

The Original Shaft Mount Reducer

SMR Series

Fully TXT compatible, mounts directly to the driven shaft

WorldWide Electric's Original Shaft Mount Reducer is dimensionally equivalent to the popular TXT series shaft mount reducers to provide you with the perfect solution for all of your most demanding applications. Designed to accept all TXT compatible accessories without issue, the Original SMR allows you to take full advantage of your existing safety stock and installed base. For new applications, WorldWide Electric offers a complete line of our own motor mounts, belt guards, tapered bushing kits and backstops to complement your existing operations.



Quick Specs & Features

- Housing: FCD45 Cast Iron
- Box Size: 2 - 12
- Speed Ratio: 15:1 and 25:1
- Compatibility: TXT Compatible, Drop-In Replacement
- Torque Arm Included
- Two-year Warranty



Responsive

Service & Technical Support



Quality Products

Competitive Pricing



In Stock Availability

Warehouses Nationwide



Fast Shipping

Same-Day Available

Product Features

- Dimensional drop-in for most major brands, including TXT
- Shaft and gears manufactured from high grade steel, case hardened and precision ground to A.G.M.A. standards
- Heavy duty FCD45 cast iron housing
- Extended gear centers and tooth contact
- Metal reinforced, spring loaded, double-lip seals
- Premium ball and tapered roller bearings
- Tapered bushing type (Tapered Bushing Kit sold separately)
- Torque arm included

Accessories

WorldWide Electric's industry grade accessories are designed to fit TXT and HXT compatible series shaft mount reducers.

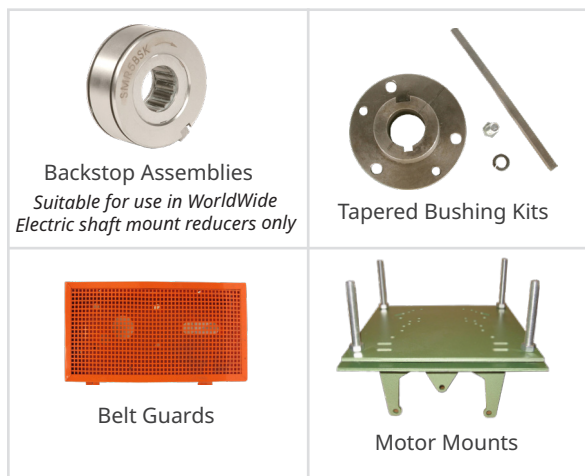

Model Number Selection

Sample Part Number: SMR3-15/1

Each model number contains the product family, box size, and ratio. When selecting ratio, replace colon with slash, e.g. 15:1 becomes 15/1.

‡ Not all combinations indicated by this table are possible. Please contact us or visit shop.worldwideelectric.com for more information on availability.

Product Family	Box Size	Ratio	Output Bore
SMR	2	15:1	1 15/16"
		25:1	1 15/16"
	3	15:1	2 3/16"
		25:1	2 3/16"
	4	15:1	2 7/16"
		25:1	2 7/16"
	5	15:1	2 15/16"
		25:1	2 15/16"
	6	15:1	3 7/16"
		25:1	3 7/16"
	7	15:1	3 15/16"
		25:1	3 15/16"
	8	15:1	4 7/16"
		25:1	4 7/16"
	9	15:1	4 15/16"
		25:1	4 15/16"
	10	15:1	5 7/16"
		25:1	5 7/16"
	12	15:1	6 1/2"
		25:1	6 1/2"

Product Overview

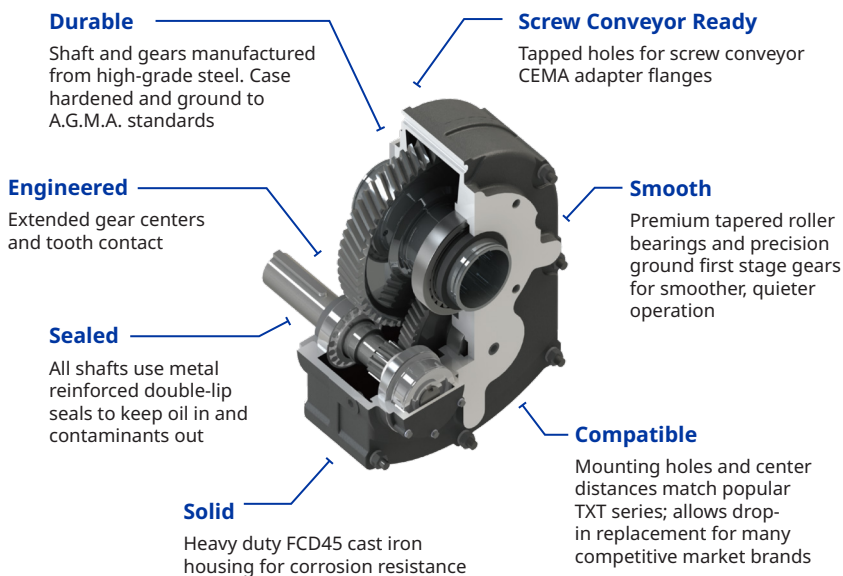

WorldWide Electric Corporation is a leading manufacturer of electric motors, motor controls, gear reducers, and generators. Offering fast, often same-day, shipping from seven regional US warehouses, WorldWide Electric takes pride in providing a competitive edge to our customers by responding to their requirements with urgency, technical expertise, and professionalism.

© Copyright 2023 WorldWide Electric Corporation

GR-SMR-v01-18-24